

Experimental Investigation of Cooling Performance a Heat Pump for Near Azeotropic Refrigerant R404A

Hayati Töre¹ and Ali Kilicarslan² 

¹ Municipality of Merzifon, Department of Mechanical Engineer, Amasya, Turkey

² Hitit University, Department of Mechanical Engineering, Çorum, Turkey

ABSTRACT

In this study, in order to investigate the effect of outdoor air temperatures on the performance of an air source heat pump, operated in cooling mode, using R404A refrigerant, the heat pump was tested at the outdoor air temperatures ranging from 25 °C to 30 °C and a computer code was also developed by using Engineering Equation Solver (EES). Experimental measurements have been carried out at the outdoor air temperatures ranging from 25 °C to 29 °C and they are repeated three times for better accuracy. The temperatures, the pressures, and the electric energy consumed by the compressor and the fans are measured by means of the K type thermocouple, bourdon type manometer and energy analyzer, respectively. Furthermore, an electric heater was installed in the room where the indoor unit was located and a humidifier is activated to provide the humidity conditions required for the room. The compressor pressure ratio, the power driven by the compressor, the heat rejection capacity of the outdoor unit, the cooling capacity of the indoor unit, the coefficient of performance of the heat pump (COP) were investigated according to different outdoor air temperatures. It was observed that as the outdoor air temperature increased, the indoor unit capacity and COP of the heat pump system decreased while the energy consumed by the compressor increased.

Keywords:

Heat pump, Cooling, Coefficient of performance, R404A

Article History:

Received: 2017/04/05

Accepted: 2017/05/24

Online: 2017/11/27

Correspondence to:

Ali Kilicarslan, Hitit

University, Department of Mechanical

Engineering, Çorum, Turkey

Tel:+903642274533/1236

Fax:+903642274535

E-Mail: alikilicarslan@gmail.com

INTRODUCTION

Halogenated refrigerants, which cause the ozone layer to be depleted and affect the global warming, have been used in the vapor compression refrigeration systems for many years. Due to these harmful effects to the environment, some national and international agreements have restricted the use of CFC (chlorofluorocarbons) and HCFC (hydrochlorofluorocarbons), and the protocol to replace these refrigerants with alternative refrigerants is underway.

There are three types of refrigerants that can be used as refrigerant instead of CFC and HCFC class refrigerants. These are called azeotropic, near azeotropic and zeotropic refrigerants [1]. Azeotropic refrigerants act as a single refrigerant at the same temperature and pressure, although these refrigerants are formed by combining two or more refrigerants. In these refrigerants, the compositions of liquid and vapor phases in thermodynamic equilibrium are identical. This means

that there is no temperature change during the phase changes under constant pressure, ie during evaporation or condensation phases. Near azeotropic refrigerants are formed by the combination of two or more refrigerants with different boiling points. These refrigerants, which have the same compositions in the liquid and vapor phases, evaporate or condense at different temperatures during the process. Despite the fact that these refrigerants have a higher potential to be developed than the azeotropic refrigerants, the leaks that may be present in the system can cause the composition and properties of the refrigerant to change.

Studies on azeotropic and near azeotropic refrigerants are generally based on energy analysis. The refrigerants are compared in terms of performance in the refrigeration cycle. Studies on exergy analysis are also found in the literature.

Refrigerants R404A and R507A which are alternative to R502 were compared by means a mathematical model developed for vapor compression refrigeration systems using evaporator and condenser temperatures of $-50^{\circ}\text{C} / 0^{\circ}\text{C}$ and $40^{\circ}\text{C} / 55^{\circ}\text{C}$, respectively. It has been shown that R507A refrigerant gives better results than R404A refrigerant in systems as the the system performance (COP), exergy destruction and efficiency are taken into consideration[2].

The HFC-161 mixture, similar in physical properties to R502 but environmentally friendly, which could be used as an alternative to the R502 refrigerant, was used as refrigerant in the vapor compression refrigeration system designed for R404A, and as a result of its operation, the pressure ratio of this new refrigerant is about the same as R404A and R502, its COP is higher than R404A at higher evaporator temperatures [3].

The general characteristics and system performances of refrigerants R402A, R402B, R403B, R408A, R404A, R407A and FX40, which may be used as an alternative to R502, have been experimentally investigated and it has been stated that the performances of all the refrigerants except R403B in the refrigeration cycle are very close to R502 [4]. In the another study, the performance of the R22 / R11 mixture with pure refrigerants and the refrigerant mixtures used from the blends of these refrigerants in the vapor compression refrigeration system has been examined [5].

The system parameters were calculated by applying numerical modeling techniques for the ground source heat pump. The computer codes of the equations obtained from the developed model for city of Bolu, Turkey were developed in Matlab program. In order to obtain the properties

of R134A, R404A and R410A, the curve fitting method was used. As a result, it was found that the COP value of R134A was 3.33 in the Matlab program and 3.28 in the Solvent Refrigerant Software program [6]. R449A and R404A were compared to each other in some ways including the compressor discharge temperature, cooling capacity and GWP (Global Warming Potential). It was observed that the refrigeration system using R449A as refrigerant has advantage on the refrigeration system using R404A as GWP and energy are taken into consideration [7].

The performance of air-source heat pump (ASHP) using R404A as refrigerant was investigated both theoretically and experimentally in heating mode at the outdoor temperatures ranging 0°C and -26°C . Furthermore, the effect of outdoor air temperature on the compressor capacity, heating capacity and discharge temperature was also investigated. It was observed that the performance of the ASHP with internal heat exchanger (IHX) was better than that of the ASHP without IHX [8].

It is seen from the literature survey that the studies related to the utilization of R404A in heat pump systems are generally based on the investigation of the effect of evaporator or condenser temperature on the performance, pressure ratio or GWP. There is only one study, similar to this study, mentioned above aiming to investigate the effect of outdoor air temperature on the compressor capacity, COP, heating capacity, discharge temperature, but the heat pump is operated in heating mode, not cooling mode.

In this study, the effect of outdoor air temperatures ranging from 25°C to 30°C on the performance of single stage vapor compression refrigeration system using R404A refrigerant is investigated both theoretically and experimentally. The experimental results obtained are inserted in the computer code developed by using EES software [9]. As a result, the power consumed by the compressor, the refrigeration capacity of the indoor unit, the heat rejection capacity of the outdoor unit, the coefficient of performance (COP) of the vapor compression refrigeration system are observed with respect to the outdoor air temperature. In addition, some important parameters including the pressure ratio, indoor air temperature in the system are also observed according to the outdoor air temperature.

MATERIAL AND METHOD

The vapor compression refrigeration system used in the experiments consists of compressor, outdoor unit, capillary tube type expansion element, indoor unit, four-way valve, low and high pressure control switch and filter drier. In addition to these, an energy analyzer measuring the amount of energy driven by the compressor and fans, four pressure gauges measuring capillary tube inlet - outlet

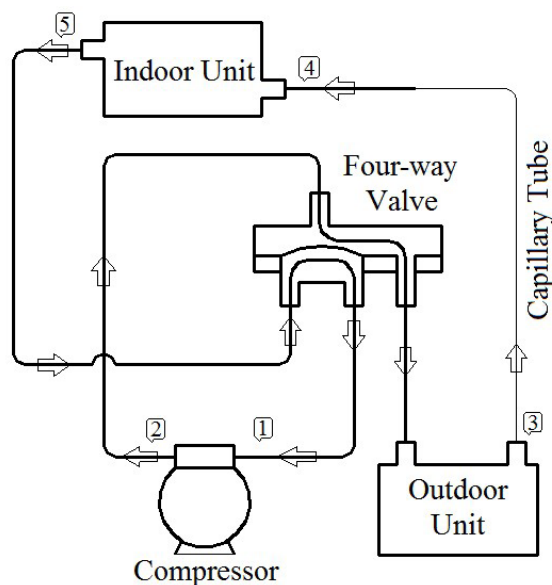

Figure 1. Heat pump cycle in cooling mode

pressures and compressor inlet - outlet pressures, CO-MET MS6D data recorder to record temperature values measured by thermo-couples, electric heater and humidifier, and a humidity meter to measure the humidity in the room are used. The experiments were repeated out three times on August 15-18, 2014 to investigate the effect of outdoor air temperatures ranging from 25 °C to 30 °C on the performance of single stage vapor compression refrigeration system using R404A refrigerant. The heat pump cycle operated in the cooling mode is schematically shown in Fig.1.

The indoor unit, energy analyzer, control panel, humidity meter and data logger are shown in Fig.2.

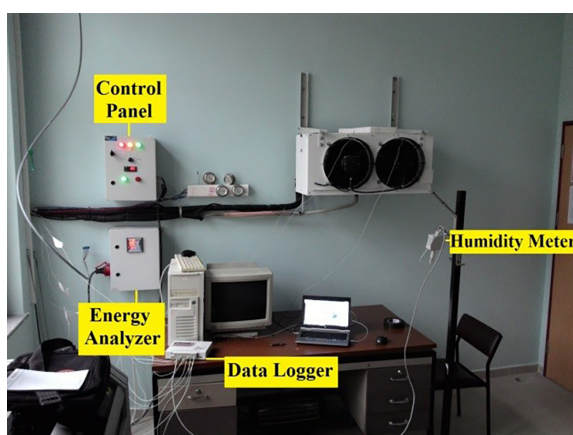

Figure 2. Indoor unit of the heat pump

The semi-hermetic type compressor, outdoor unit, four-way valve, low and high pressure control switch (presostat) used in the heat pump system are shown in Fig.3.

For the open system, the first law of thermodynamics is expressed as [10],

$$\frac{dE_{c.v.}}{dt} = \sum_i \dot{m} h - \sum_e \dot{m} h + \dot{Q}_{c.v.} - \dot{W}_{c.v.} \quad (1)$$

In this study, some assumptions were made in thermodynamic analysis;

- The pressure losses in the pipeline between the indoor unit, the outdoor unit and the elements in the refrigeration system have been neglected.
- It is assumed that the heat pump operating in the refrigeration mode and steady-state and steady flow conditions.
- It is also assumed that the electrical power taken by the compressor is converted into the mechanical power.
- Changes in kinetic and potential energies in the heat pump cycle are neglected.

Taking the above considerations into account;

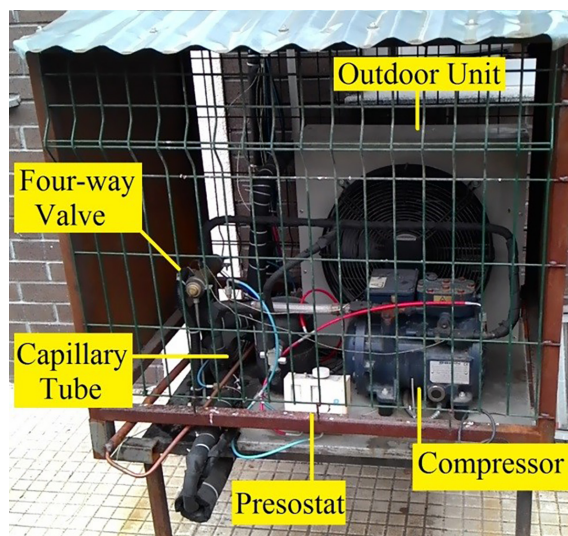

Figure 3. Outdoor unit of the heat pump

Applying the energy equation for steady-state steady flow process (SSSF) to the elements of the heat pump, the following equations are derived for the elements of the heat pump system.

Compressor;

$$\dot{W} = \dot{m}(h_1 - h_2) \quad (2)$$

Outdoor unit;

$$\dot{Q}_{ou} = \dot{m}(h_4 - h_2) \quad (3)$$

Indoor unit;

$$\dot{Q}_{iu} = \dot{m}(h_5 - h_4) \quad (4)$$

Capillary tube;

$$h_3 = h_4 \quad (5)$$

The coefficient of performance (COP) of the heat pump can be expressed as:

$$COP = \frac{\dot{Q}_{iu}}{\dot{W}_{comp} + \dot{W}_{iu} + \dot{W}_{ou}} \quad (6)$$

\dot{W}_{iu} and \dot{W}_{ou} are measured by means of energy analyzer for constant fan speeds as 0.88 kW.

Uncertainty Analysis of the Experimental Results

The uncertainties of the measurements that are used to calculate the uncertainties associated with \dot{m} , \dot{Q}_{iu} , \dot{Q}_{ou} , \dot{W}_{comp} , and COP are $\pm 0.5\%$ for power analyzer, ± 1.5 for K type thermocouple and $\pm 3\%$ for manometer. The total uncertainties related to \dot{m} , \dot{Q}_{iu} , \dot{Q}_{ou} , \dot{W}_{comp} , and COP are estimated to be 2.03%, 3.03%, 1.74%, 0.45% and 2.99 respectively.

RESULTS AND DISCUSSION

The effect of outdoor air temperature on the performance of vapor compression refrigeration system was experimentally investigated in a heat pump system operated in cooling mode. A computer code was developed for this purpose. In the following section, the results are presented in the figures and discussed in detail.

Figure 4 shows the change of the pressure ratio of the compressor with respect to the outdoor air temperature. Theoretically, when the outdoor air temperature increases, this causes to the indoor air temperature to increase. In this case, more heat will be transferred to the indoor unit and consequently the compressor inlet pressure corresponding to the saturation temperature of the refrigerant in the indoor unit will increase. In addition, as the outdoor air tem-

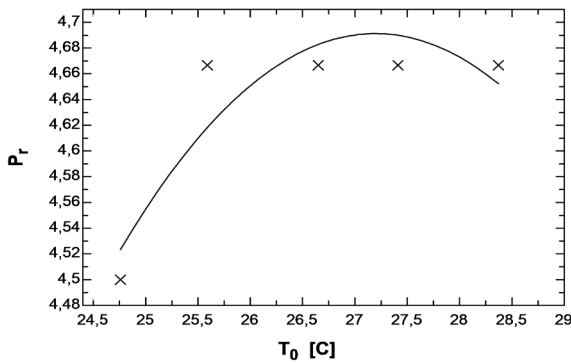

Figure 4. Variation of pressure ratio as a function of outdoor air temperature

perature increases, the temperature difference between the outdoor unit and the surroundings decreases, resulting in a reduction in the amount of heat rejected to the surroundings and in this case the compressor outlet pressure corresponding the saturation temperature of the refrigerant in the outdoor unit will increase. As shown in Fig. 4, the pressure ratio increases due to the relative increase in the outlet pressure to the inlet pressure. At the outdoor temperatures ranging from 24.5 °C to 28.5 °C, the pressure ratio ranges from 4.5 to 4.67. One can conclude from Figure 4 that the pressure ratio has approximately the same value as 4.67 for all the of the outdoor temperatures except the outdoor temperature of 24.75 °C

Figure 5 shows the power consumption of the compressor with respect to the outdoor air temperature. As the outdoor air temperature increases, the pressure ratio of the compressor increases. This increase in pressure ratio of the compressor results in an increase in the power consumed by the compressor. As the outdoor temperatures increases from 24.5 °C to 28.5 °C, the power required by the compressor increases 1.56 kW to 1.63 kW. The maximum compressor power of 1.63 kW is reached as the outdoor temperature is also maximum, namely 28.5 °C

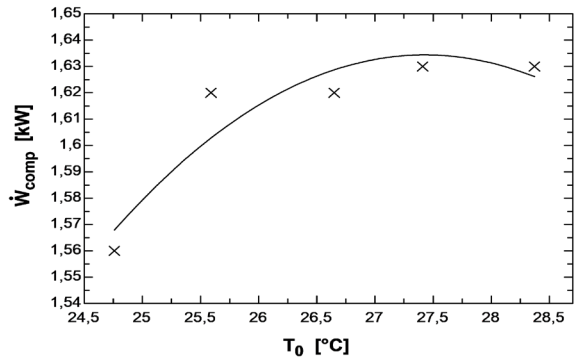

Figure 5. Variation of compressor power consumption as a function of outdoor air temperature

While the average outdoor air temperature for R404A increases by 14.58%, the increase in the pressure ratio is 3.71% while the energy consumption of the compressor is 3.85%.

Figure 6 shows the variation of outdoor unit capacity with respect to outdoor air temperature. As can be seen from Fig. 6, as the outdoor air temperature increases, the heat rejection capacity of the outdoor unit decreases. As the outdoor air temperature increases, the temperature difference between the outdoor unit and the outdoor air decreases, and this cause to the capacity of outdoor unit to decrease. At the outdoor temperatures ranging from 24.5 °C to 28.5 °C, the outdoor unit capacity of heat pump decreased

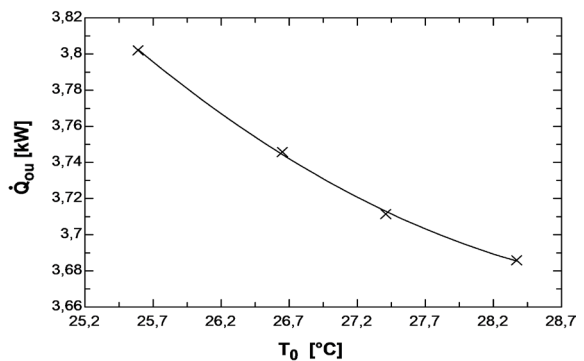

Figure 6. Change of outdoor unit capacity as a function of outdoor air temperature

from 3.80 kW 3.68 kW. It has been found that the outdoor air temperature increases by 10.78% for the R404A refrigerant while the outdoor unit capacity decreases by 5.77% on average.

Figure 7 shows the variation of indoor unit capacity with respect to outdoor air temperature. As the outdoor air temperature increases, the capacity of the indoor unit decreases for R404A refrigerant as shown in Fig.7. At the minimum outdoor temperature of 24.6°C, the indoor unit capacity is 2.14 kW and then it increases sharply to a capacity of

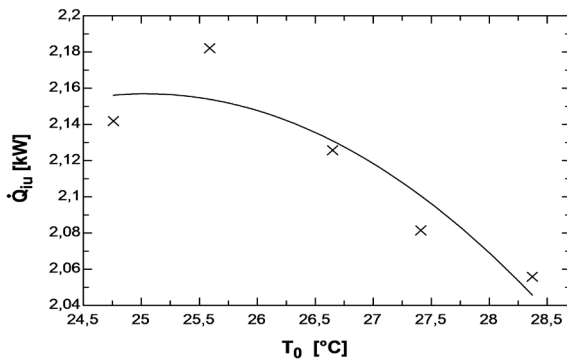

Figure 7. Change of indoor unit capacity as a function of outdoor air temperature

2.18 kW, later it decreases smoothly and finally it reaches a minimum capacity of 2.05 kW at a temperature of 28.3 °C. When the outdoor air temperature increases, the indoor temperature for R404A increases by 0.26 °C. As a result, there has not been a significant change in indoor unit capacity since there is not much increase in indoor temperature.

Figure 8 shows the change in the coefficient of performance (COP) of the heat pump with respect to the outdoor air temperature. As a measure of performance, the COP is a function of the amount of heat absorbed by the indoor unit and the power drawn by the compressor. In this experimental study, the energy consumed by indoor and outdoor unit fans was taken into account in the determination of COP. The decrease in the indoor unit capacity (Fig.7) and increase in the power drawn by the compressor (Fig.5) caused

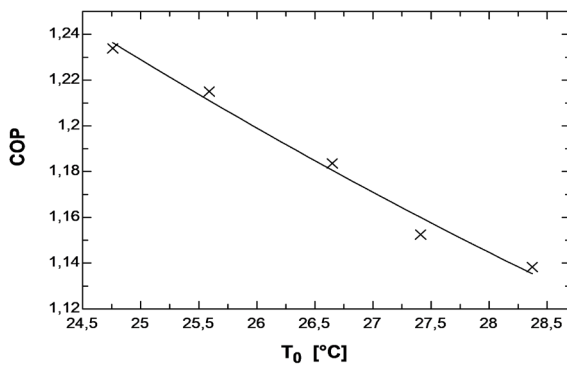

Figure 8. Change of refrigeration coefficient as a function of outdoor air temperature

COP to decrease as the outdoor air temperature increased as shown in Figure 8. The COP of the heat pump decreases from 1.23 to 1.13 at the outdoor temperatures between 24.5 °C to 28.5 °C. When Figure 8 is analyzed, the COP of the heat pump using R404A as refrigerant decreases by 1.138 at the outdoor temperatures ranging from 24.5 °C to 28.5 °C.

Figure 9 shows the change of the indoor air temperature with respect to the outdoor air temperature. As the outdoor air temperature increases, more heat will be transferred to the indoor environment, this cause to the indoor air tem-

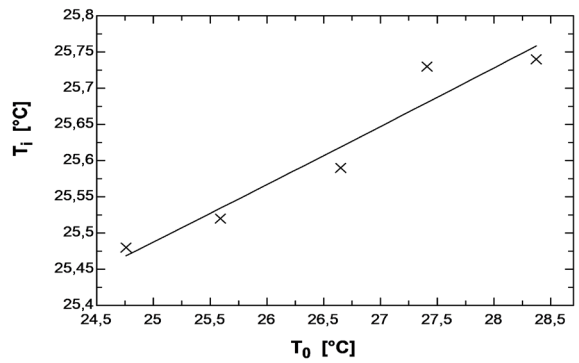

Figure 9. Change of indoor air temperature as a function of outdoor air temperature

perature to increase as shown in Fig.9. As the outdoor air temperature increases, the indoor air temperature slightly increases in the heat pump system operated in the cooling mode for refrigerant R404A. As the outdoor air temperature increases by 16.6% on average, the indoor temperature increases by 13.4% on average as it is shown in Figure 9.

CONCLUSION

The effect of outdoor air temperatures ranging from 24.5 °C to 28.5 °C on the performance of heat pump system operated in the cooling mode using R404A refrigerant was experimentally performed by using a computer code developed .

The important results obtained from this experimental work can be summarized as follows,

- As the outdoor air temperature increases, there is not much change in the compressor inlet and outlet pressure, but there is a slight increase in the compressor pressure ratio. The pressure ratio of the heat pump system is around 4.5. Along with the increase in the outdoor air temperature, the increase in the pressure ratio of the compressor has been observed to increase. The power required by the compressor increases 1.56 kW to 1.63 kW. The energy consumption of the compressor is 3.85%.

- It was determined that the temperature difference between the outdoor unit and the surroundings decreases and the outdoor unit capacity decreases as the outdoor air temperature increases. The outdoor unit capacity of heat pump decreases from 3.80 kW to 3.68 kW and this corresponds to 5.77% decrease on average in the outdoor unit capacity.

- As the outdoor air temperature increases, the indoor air temperature increases slightly as 0.26 °C, this results in a slight increase in the indoor unit capacity. As a result, there is no significant increase in indoor air temperature.

- It was also observed that as the outdoor air tempera-

ture increases, the indoor unit capacity decreases while the energy consumed by the compressor increases, and thereby decreasing the COP of the heat pump system. The COP of the heat pump decreases from 1.23 to 1.13 at the outdoor temperatures between 24.5 °C to 28.5 °C.

• As the outdoor air temperature increases, the increase in the indoor air temperature can be almost neglected.

ACKNOWLEDGMENT

We are grateful to Hitit University Scientific Research Projects Unit for supporting this project numbered (MUH19004.14.005)

REFERENCES

1. Didion D. A., Bivens D. B., 1990. Role of Refrigerant Mixtures as Alternatives to CFCs, *International Journal of Refrigeration*, 13(3), 163–175.
2. Arora A., Kaushik S.C., 2008. Theoretical Analysis of a Vapour Compression Refrigeration System with R502, R404A and R507A, *International Journal of Refrigeration*, 31(6), 998–1005.
3. Xuan Y., Chen G., 2005. Experimental study on HFC–161 mixture as an alternative refrigerant to R502, *International Journal of Refrigeration*, 28(3), 436–441.
4. Aprea C., Mastrullo R., Rossi F., 1996. Behaviour and Performances of R502 Alternative Working Refrigerants in Refrigerating Plants, *International Journal of Refrigeration*, 19(4), 257–263..
5. McLinden M.O., Radermacher R., 1987. Methods for Comparing Performance of Pure and Mixed Refrigerants in the Vapour Compression Cycle, *International Journal of Refrigeration*, 10(6), 318–325.
6. Camdali, U., Bulut, M., Sozbir, N., 2015. Numerical modeling of a ground source heat pump: The Bolu case. *Renewable Energy*, 83, 352–361.
7. Makhnatch, P., Babiloni, A.M., Rogstam, J., Khodabandeh, R., 2017. Retrofit of lower GWP alternative R449A into an existing R404A indirect supermarket refrigeration system, *International Journal of Refrigeration*, 76, 184–192.
8. Jin, L., Cao, F., Yang, D., Wang, X., 2016. Performance investigations of an R404A air–source heat pump with an internal heat exchanger for residential heating in northern China, *International Journal of Refrigeration*, 69, 239–248.
9. Klein, S.A., 2010, *Engineering Equation Solver (EES), Professional version V9.723–3D, F–Chart Software*.
10. Borgnakke, C., Sonntag, R.E., 2009. *Fundamentals of Thermodynamics*, Seventh Ed., John Wiley & Sons, Inc.