

A Monitoring and Control System Integrated with Smart Phones for The Efficient Use of Underground Water Resources in Agricultural Product Growing

Mehmet Fatih İŞİK¹  Mustafa Reşit HABOĞLU²  Ercan İŞİK³ 

¹ Hitit University, Department of Electrical and Electronics Engineering, Çorum, TURKEY

² Hitit University, Department of Mechanical Engineering, Çorum, TURKEY

³ Bitlis Eren University, Department of Civil Engineering, Bitlis, TURKEY

ABSTRACT

Monitoring and control system is very important for crop development process in agriculture zones. A structure which is carried out based on the type of the product with the knowledge of temperature and humidity values of the agricultural land can contribute to the efficient use of underground water resources. Additionally, it can also contribute to the establishment of the administration of the land besides the economical contributions to the farmer. In this study, the values obtained by heat and humidity sensors which are placed in different locations of agricultural field are transmitted to a database by using a central operation unit. The water requirement based on the product is determined according to that database. Those values are transferred to the smart phones by using a Wi-Fi connection. A real time monitoring system is established on the smart phone. The energy supply of the system is obtained by solar cells. The design offers several advantages such as saving of the water, time and energy with the efficient use of underground water resources. Thus, by using clean energy, the design constitutes an environmental friendly system.

Keywords:

Agriculture zone, Smart phone, Underground water, Sensor networks

Article History:

Received: 2017/01/25

Accepted: 2017/07/31

Online: 2017/10/11

Correspondence to: M.Fatih Isik, Hitit University, Department of Electrical and Electronics Engineering
E-Mail: mehmetfatih@hitit.edu.tr

INTRODUCTION

The insufficiency of the water resources in the world has led to the necessity for the watering to be more sensitive. Especially for the fields that does not have any watering system, the watering is supplied with underground water resources by using wells. The true use of underground water resources is important for the economical reasons as well as for the ecological balance. That situation has made interdisciplinary work necessary for both commercial and academically studies. When the situation is considered in Turkey, the technological developments should contribute more in ecological system and the administration of agricultural lands. Many new technological procedures are being used for the monitoring and control of agricultural lands [1-4]. Tablets and smart phones are becoming more widespread as the technology develops [5-15].

The main aim of this study is to develop an overall monitoring and control system for the efficient use of underground water resources in agricultural lands. An information platform is established for the agricultural land by temperature and humidity sensors. The values obtained by the sensors are transferred to a central database. That database is also present on a web based server as it can be reached by a Wi-Fi structure. The only arrangement that the farmer should do is choosing the plant for that season. The system performs all the operations according to the chosen plant automatically. Those operations contain initial, crop development, mid season and late season periods. This study also comes forward with the usage of clean energy. The energy costs are reduced by using renewable energy with the help of solar panels placed on the agricultural land.

The determination of the water requirement ac-

According to the product development periods can contribute to the true use of underground water resources. Especially in drip irrigation systems, the plant is subjected to a small amount of water continuously. In this study, smart use of water according to the production stage is used instead of that system. The United Nations Food and Agriculture Organization (FAO) recommends Penman Monteith method developed to determine crop water requirement. It is aimed to calculate the healthy evapotranspiration with the crop coefficient (kc) determined by the specific data of the irrigation area. The reference evapotranspiration (ET₀) has been used and required climate data have been obtained from internet site of Turkish State Meteorological Service (www.mgm.gov.tr) in order to account using the FAO Penman Monteith method [16].

$$ET_0 = \frac{0,408 * \Delta * (R_n - G) + \gamma * (\frac{900}{T+273}) * u_2 * (e_s - e_a)}{\Delta + \gamma * (1 + 0,34 * u_2)} \quad (1)$$

Here,

ET₀: Reference evapotranspiration (mm day⁻¹),

R_n: Net radiation (MJ m⁻² day⁻¹),

G: Soil temperature flux density (MJ m⁻² day⁻¹),

T: The average daily air temperature (°C),

U₂: 2 m height wind speed (m s⁻¹),

e_s: Saturated vapor pressure (kPa),

e_a: Actual steam pressure (kPa),

Δ: The slope of the vapor pressure curve (kPa /°C⁻¹),

γ: Psychometric constant (kPa).

EXPERIMENTAL STUDY

The Agriculture Zone situated in the Çorum/Mecitözü in the Middle Black Sea region of Turkey has the latitude 41°51'N and the longitude 35°29'E. The altitude is 750 m above the sea level. Climate data obtained from the me-

teorological station that belong to Çorum/Mecitözü are shown in Table 1.

The obtained climate data and the values of crop water requirements depending on seasonal development are shown in Table 2. According to the table, the total water demand in the process of growing the product has been identified as 362,1 mm/dec.

The experimental study is carried out in a tomato land with 200 m² in Mecitözü. The plan of the control and monitoring system along with the home page screenshot of smart phone are given in Figure 1. Ground water that is transfer-

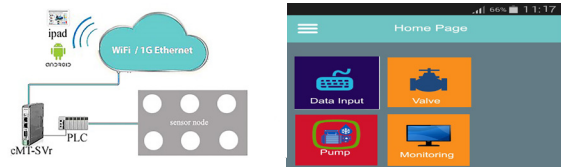

Figure 1. Functional diagram of the monitoring and control and home page screenshot

red from the well to the water tank with 500 Lt by the booster has been connected to irrigation laterals via a filter. The required energy for the agriculture zone control and monitoring system are obtained by solar panels.

A Programmable Logic Controller (PLC) is used as the hardware in the study. The output of the PLC is a pump while the inputs are sensors. An IOS/Android server is connected to the PLC and the mobile devices are communicating with the server via a Wi-Fi router. The server provides direct communication between the mobile devices and the addresses on the PLC. At this point, monitoring and control of the system with the IOS/Android devices is possible with a developed software. The program called Easy Builder Pro

Table 1. Çorum/Mecitözü Climate/ET₀ data

Month	Avg. Temp °C	Humidity %	Wind km/day	Sun hours	Rad MJ/m ² /day	ET ₀ mm/day
January	0.2	77	120	2.5	5.7	0.61
February	1.5	75	155	3.6	8.5	0.89
March	5.3	68	164	5	12.6	1.57
April	10.9	64	172	6.1	16.7	2.58
May	15.5	60	172	7.2	19.9	3.63
June	18.9	53	172	8.7	22.7	4.62
July	21.6	45	216	9.9	23.9	5.64
August	21.4	47	207	9.9	22.3	5.22
September	17.4	57	172	8.3	17.4	3.53
October	12.4	65	130	5.6	11.2	1.95
November	7	70	147	3.6	7	1.16
December	2.2	78	130	2.1	4.9	0.66
Average	11.2	63	163	6	14.4	2.67

Table 2. Crop Water Requirements

Month	Stage	Kc [coeff]	ETc [mm/dec]	Effrain [mm/dec]	Irr. Req. [mm/dec]
April	Initial	0.57	7.7	10.8	0
April	Initial	0.57	14.7	19.7	0
April	Development	0.57	16.8	19	0
May	Development	0.64	21	18.4	2.6
May	Development	0.74	27	18.2	8.9
May	Mid	0.85	37.2	16.1	21
June	Mid	0.89	38.1	14.1	23.9
June	Mid	0.89	41	12.4	28.6
June	Mid	0.89	44	9.5	34.5
July	Mid	0.89	47.6	5.7	41.9
July	Mid	0.89	50.9	2.5	48.4
July	Mid	0.89	54.3	3.2	51.2
August	Late	0.89	48.1	4	44
August	Late	0.77	41.1	4.2	36.9
August	Late	0.6	25.6	4.3	20.3
			514.9	162.2	362.1

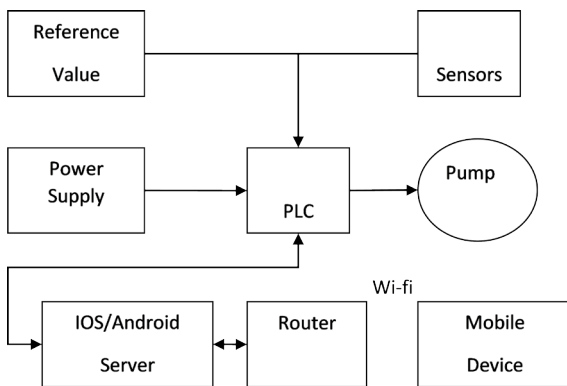

Figure 2. The block diagram of the designed set

that is developed by Weintek Corporation is used as that software. The program starts with introducing the PLC to

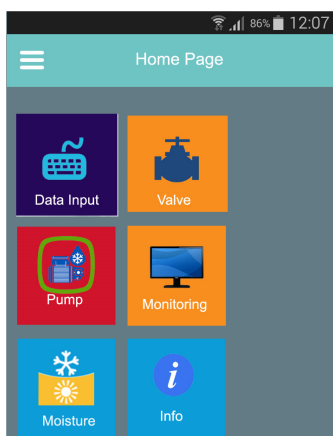

Figure 3. The mobile application screen

the software. After that, the addresses to monitor and control the desired parameters should be identified. In this study, the data collected from the sensors is transmitted to the

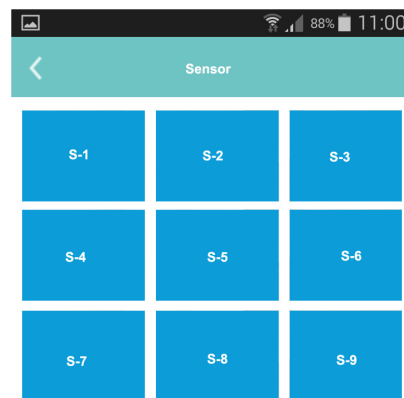

Figure 4. The moisture screen on mobile device

PLC through the web. Each parameter has a valid address that can be accessed from the Easy Builder Pro which is installed on the mobile device. The closed loop block diagram of the designed system is presented in Fig. 2.

The mobile interface initialization screen is presented in Fig. 3. The parameters for different crops can be specified through the "Data Input" option. Thus, an irrigation chart for different crops can be obtained. The manual control of the valves can be obtained via the "Valve" option while the "Pump" option controls the on/off actions for the pump. The "Monitoring" option shows the situations for the pump and the valves. The data collected from the sensors can be viewed with the "Moisture" option. Finally, the "Info" option

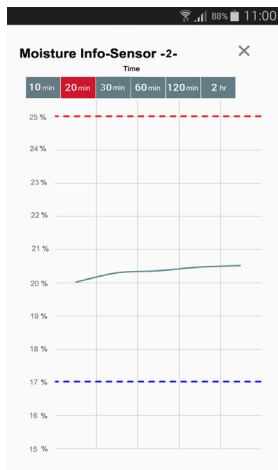

Figure 5. The moisture values obtained from Sensor 2.

presents information about the software.

The Fig. 4 shows the moisture screen that collects data from DS200 moisture sensors that are located in the different points of the field. There are 9 moisture sensors used in this study. Fig. 5 shows an example data collected from Sensor 2. The moisture values collected from sensors are displayed as percentages. It is possible for the user to monitor the moisture values in a desired time interval.

Fig. 6 shows the example execution field that the study is applied.



Figure 6. An example of the application

RESULTS AND DISCUSSION

Planting date from April to harvest; average monthly temperature results obtained from sensors in agriculture zone have been given in Fig. 7. As can be seen in Fig. 7, temperature rate is almost constant during the all stages. The temperature values of the land are measured in initial, development, mid-season and late season stages. That period covers a total time of 5 months. The highest temperature is about 18°C which appears to occur in the mid-season. On the other hand, the lowest temperature is about 13°C that is around the initial stage. The graph contains data which are the average of the daily measured values..

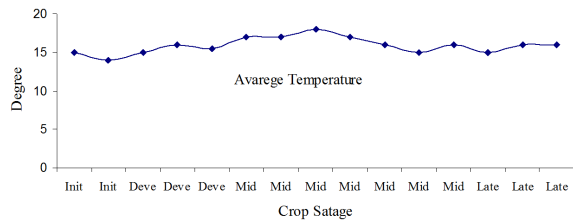

Figure 7. Monthly average temperature

Figure 8 shows the processing screen for the moisture values collected from the sensors. The data presented in the graph is collected in the mid-season and it shows the percentage of the moisture. Moisture rate decreases especially during the effects of the sun. When this situation is compared with the climatic data, it is seen that these results are close to the average values.

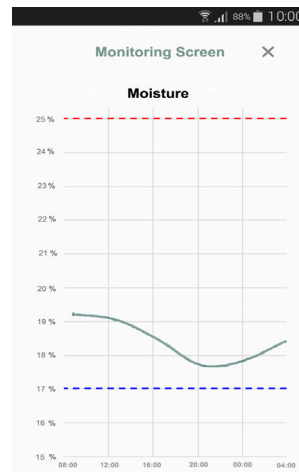

Figure 8. The average moisture values occurring in the sensors during day

The water consumption values for the growth stages are presented in Figure 9. The figure contains the irrigation values for both the developed system and conventional drip irrigation systems. Additionally, the water requirements for the growth stages are also presented in the figure. It can be seen that the irrigation values for the developed system fits very well with the water requirements curve. As a result, the developed system contributes %38 more underground water savings when compared with the conventional drip irrigation system.

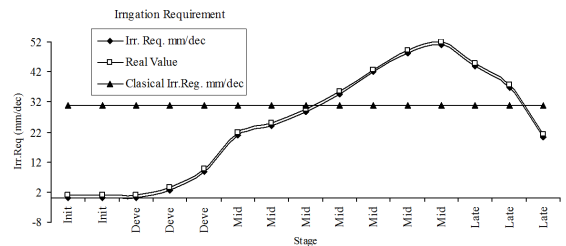

Figure 9. Comparison amount of water depending on the stage of plant growth and used amount of water

CONCLUSION

This study shows that ground water irrigation system with moisture and temperature sensors are extremely advantageous for growing crops in agricultural systems. A very important advantage is obtained by adjusting the amount of ground water needed in the plant growth stages and by consuming the water depending on the soil moisture and temperature with classic drip irrigation systems. Amount savings has been achieved in energy costs by using solar energy. The system can be operated integrating with smart phones. Hence, the whole system can be controlled and monitored by these devices which is an indispensable instrument of modern technology. Besides the efficient use of underground water resources, this study also constitutes an effective structure for the administration of the agricultural lands.

The designed system constitutes the monitoring and control of the amount of water inside the land which is based on the stage of the plant growth. A future work may focus on the optimization techniques to provide more precise irrigation for the plant growth. The combination of the data gathered from past rainfall values and moisture levels inside the land might be the main contributions for the optimization. The agricultural systems will benefit from that system as more precise information is gathered for the facts such as the need of water for the plant growth and the exact time of growth stages.

ACKNOWLEDGEMENTS

This study is the extended paper which is previously published in the book of abstracts in International Conference on Green Development Infrastructure Technology in 2016 that is held in Skopje / Macedonia.

REFERENCES

1. Weng Q. *Advances in environmental remote sensing: sensors, algorithms, and applications (remote sensing applications series)*. CRC Press Taylor & Francis Group; (2011).
2. Committee on the earth system science for decisions about human welfare: contributions of remote sensing, contributions of land remote sensing for decisions about food security and human health, workshop report. Washington: National Academies Press, (2007).
3. Pierce FJ, Clay D. *GIS applications in agriculture*. CRC Press Taylor & Francis Group; (2007).
4. El-Kader SMA, Basma M. Mohammad El-Basioni. Precision farming solution in Egypt using the wireless sensor network technology. *Egyptian Informatics Journal* 14(3) (2013) 221-233.
5. Broeders J, Croux D, Peeters M, Beyens T, Duchateau S, Cleij TJ, Wagner P, Thoelen R, De Ceuninck W. Mobile application for impedance-based biomimetic sensor readout. *IEEE Sensors Journal* 13(7) (2013) 2659-2665.
6. Ishigaki Y, Matsumoto Y, Ichimaya R, Tanaka K. Development of mobile radiation monitoring system utilizing smartphone and its field tests in Fukushima. *IEEE Sensors Journal* 13(10) (2013) 3520-3526.
7. Lee J, Reyes BA, McManus DD, Maitas O, Chon KH. Atrial fibrillation detection using an iPhone 4S. *IEEE Transactions on Biomedical Engineering* 60(1) (2013) 203-206.
8. Koukomidis E, Martonosi M, Peh LS. Leveraging smartphone cameras for collaborative road advisories. *IEEE Transactions on Mobile Computing* 11(5) (2012) 707-723.
9. Qin C, Bao X, Choudhury RR, Nelakuditi S. TagSense: Leveraging smartphones for automatic image tagging. *IEEE Transactions on Mobile Computing* 13(1) (2014) 61-74.
10. Car NJ, Christen EW, Hornbuckle JW, Moore GA. Using a mobile phone short messaging service (SMS) for irrigation scheduling in Australia-Farmers' participation and utility evaluation. *Computers and Electronics in Agriculture* 84 (2012) 132-143.
11. Sallabi F, Fadel M, Hussein A, Jaffar A, El Khatib H. Design and implementation of an electronic mobile poultry production documentation system. *Computers and Electronics in Agriculture* 76(1) (2011) 28-37.
12. Arroqui M, Mateos C, Machado C, Zunino A. RESTful Web services improve the efficiency of data transfer of a whole-farm Simulator accessed by Android smartphones. *Computers and Electronics in Agriculture* 87 (2012) 14-18.
13. Montoya FG, Gomez J, Cama A, Zapata-Sierra A, Martinez F, De La Cruz JL, Manzano-Agugliaro F. A monitoring system for intensive agriculture based on mesh networks and the Android system. *Computers and Electronics in Agriculture* 99 (2013) 14-20.
14. M. Sait TAHMISCIOGLU "T.C. Orman ve su isleri bakanlığı devlet su isleri genel müdürlüğü, Türkiye' de bitki su tüketimi çalışmaları", Etüt, Planlama ve Tahsisler Dairesi Başkanlığı, Mart, (2015).